

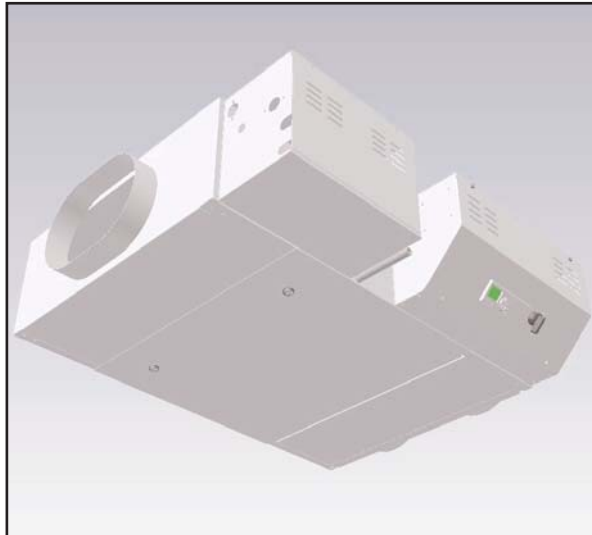

## JS HumiPac™

### Installation, Operating, and Instruction Manual



**JS Humidifiers plc**  
Artex Avenue, Rustington  
LITTLEHAMPTON  
West Sussex BN16 3LN  
United Kingdom

Telephone: 01903 850200  
International code +44 1903 850200  
FAX: 01903 850 345  
International Code +44 1903 850 345  
email: [sales@jshumidifiers.com](mailto:sales@jshumidifiers.com)  
web: [www.jshumidifiers.com](http://www.jshumidifiers.com)

## JS HumiPac™ Series 4.0





# JS HumiPac™ Humidifier Installation and Instruction Manual Safety

## GENERAL

This manual contains all details necessary for the planning and installation of the JS HumEvap™ Evaporative Humidifier. In addition commissioning, operating and maintenance details are included.

The manual is intended for use by engineers and properly trained technical personnel. Maintenance, servicing or repair work must only be carried out by suitably skilled and qualified personnel, the customer MUST be responsible for ensuring their suitability.

Any risks or hazards, especially when working from ladders or towers, should be identified by a skilled and competent Health & Safety representative and effective control measures put in place.

No liability will attach to JS Humidifiers plc if any damage, injury or accident is attributable to inattentive, inappropriate, negligent or incorrect operation of the machinery whether or not caused deliberately.

Always isolate all electrical and water supplies before commencing any maintenance. Please contact JS Humidifiers plc if in any doubt.

## HEALTH AND SAFETY

Your attention is drawn to the Health and Safety Executive's Approved Code of Practice (ACoP) and their technical guidance on the prevention and control of legionellosis in water systems. Water systems, if not adequately maintained, can support the growth of micro-organisms including the bacterium that causes Legionnaires' disease.

JS Humidifiers Plc has considered all aspects of the design of their humidification systems to reduce as far as possible the risk of Legionnaires' disease and other similar conditions but it is important that users are also aware of their responsibilities under the ACoP in reducing the risk of legionellosis.

To prevent the growth of legionella, users are required to:

Avoid water temperatures that favour the growth of legionella (20-45°C)

Avoid water stagnation.

Clean and disinfect the humidification system in accordance with the ACoP and enclosed instructions

Carry out a risk assessment of the water system supplying the humidifier by a competent person, to ensure that the water supply is of an acceptable quality.

In the event that the unit is turned off for prolonged periods, ensure that any water storage tanks and pipe-work supplying the unit are also drained, unless they supply other systems which ensure a regular renewal of water in the system. Failure to do so may result in stagnation of the water and contamination.

## CORRECT USE

JS HumEvap™ humidifiers are designed for use for humidification or cooling by evaporation and any other or further application is not considered use for the intended purpose. The manufacturer cannot be made liable for any damage resulting from incorrect use.

## WATER

JS Humidifiers systems are designed to be used with mains or reverse osmosis water. On no account attempt to introduce any other fluid or chemical into the system without first consulting JS Humidifiers plc.

Water supply must not exceed 7.0 Bar and installation should comply with local regulations.

## ELECTRICITY

All work concerned with electrical installation MUST only be performed by skilled and qualified technical personnel. (e.g. electrician or technicians with appropriate training). The customer MUST be responsible for ensuring their suitability.

Please observe the local regulations concerning the provision of electrical installations.

## NOTE

Our policy is one of continuous research and development. We therefore reserve the right to amend without notice the specifications given in this document.



# JS HumiPac™ Humidifier Installation and Instruction Manual Declaration of Conformity

## Declaration of Conformity



### Directives Applied

Electromagnetic Compatibility Directive 89/336/EEC  
Low Voltage Directive 73/23/EEC

### Standard(s) to which Conformity is declared

EN50081-1:1992 - Electromagnetic compatibility. Generic emission standard.  
-Residential, commercial and light industry.  
EN50081-2:1994 - Electromagnetic compatibility. Generic emission standard.  
-Industrial environment.  
EN60204-1:1998 - Safety of machinery. Electrical equipment of machines.  
EN292 Parts 1 & 2:1991 - Safety of machinery.

### Manufacturer's Name And Address

JS Humidifiers plc  
Artex Avenue,  
Rustington,  
LITTLEHAMPTON, WEST SUSSEX,  
BN16 3LN (UK)  
Tel: 01903 850200

### Type of Equipment

JS HumiPac™ Humidifier

### Model Name(s) & Series No.

HumiPac CM20T

2005

### Year of Manufacture

I, the undersigned, hereby declare that the equipment specified above conforms to the above Directive(s) and Standard(s)

Signature:

Name:

S.P. Verney

Position:

Managing Director



## JS HumiPac™ Humidifier Installation and Instruction Manual Standards and Certificates

### WRAS Certificate



### WRAS Scheme

The Water Regulations Advisory Scheme operates on behalf of the water companies of England and Wales, and the water authorities of Scotland and Northern Ireland. It examines and tests water fittings. This ensures compliance with the appropriate regulations concerning waste, undue consumption, misuse or contamination of the mains water supply.

WRAS certification ensures that all statutory water undertakers will accept the HumiPac™ system as complying with all Regulations and Byelaws concerned with connection to the mains water supply.

For further information contact:

Water Regulations Advisory Scheme  
Fern Close, Pen - y - Fan Industrial Estate  
Oakdale, Gwent, NP11 3EH  
01495 248454



# JS HumiPac™ Humidifier Installation and Instruction Manual Contents

---

<b>Page</b>	<b>INTRODUCTION</b>
(i)	Safety
(ii)	Declaration of Conformity
(iii)	Standards and Certificates
(iv)	Contents
(v)	Principle of Operation
	<b>INSTALLATION</b>
<b>Page 1</b>	Positioning
<b>Page 2</b>	Fixing to the Ceiling
<b>Page 3</b>	Water Connections
<b>Page 4</b>	Air Connections
<b>Page 5</b>	Electrical Connections
	<b>COMMISSIONING</b>
<b>Page 6</b>	Start Up
<b>Page 7</b>	Operating the Controller
	<b>MAINTENANCE</b>
<b>Page 8</b>	Air Filter
<b>Page 9</b>	Humidification Cassette
<b>Page 10</b>	Water Spray bar / Pump
<b>Page 11</b>	Water Filter / Humidity Sensor
<b>Page 12</b>	Fault Diagnostic/Alarms
<b>Page 13</b>	Technical Specification
<b>Page 14</b>	Service



# JS HumiPac™ Humidifier

## Installation and Instruction Manual

### Principle of Operation

#### GENERAL

The JS HumiPac™ Ceiling Humidifier has been specifically designed to provide humidification for both large and small areas which are not otherwise humidified, either by dedicated air handling system or other means. It is a low energy humidifier using cold water which is dissipated through a moisture absorbing humidification cassette and integral fan. Dry inlet air is drawn from the environment via a suitable inlet diffuser and flexible duct into the unit where it is filtered through an antibacterial air-filter before passing through the moisture-absorbing, evaporative humidification cassette. Moisture evaporates into the air stream, raising the relative humidity and cooling the air. The moist air is then ducted to the point of need and expelled through suitable outlet diffusers. Each unit is designed for fixing to the ceiling to save space and can be hidden behind a suspended ceiling system for discreet operation.

#### CONTROL OPTIONS

Units can interface with a building management system allowing real time control and and fault monitoring through volt free contacts.

#### HYGIENE CONTROL

Periodically, HumiPac™ flushes and drains the water handling system. This effectively cleanses the water handling system. Additionally the water passes through an anti-bacterial silver ion device ensuring a safe water supply to the moisture absorbing humidification cassette which itself is impregnated with an anti-bacterial agent. Should the HumiPac™ unit be switched off for any period of time, refer to section entitled 'Disinfection of water system'.

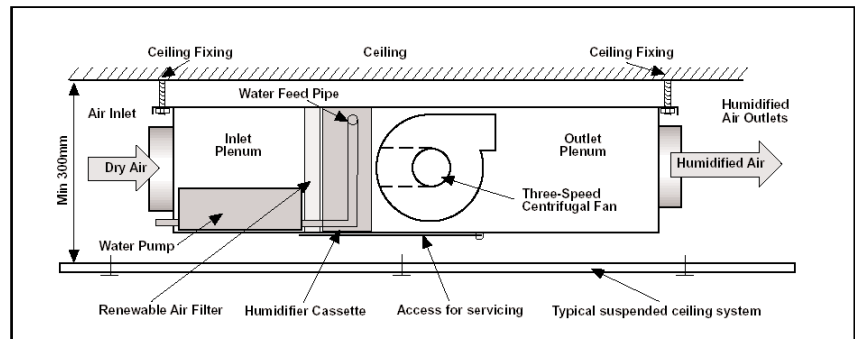

▲ Schematic diagram of the JS HumiPac™ Ceiling Humidifier

#### DISIFIN PURIFICATION TABLETS

“Disifin” is an odourless, chlorine based tablet for periodic refreshing of the humidifier.

Wearing appropriate hand and eye protection, place tablet (as specified below) in tank and allow to dissolve. Run the humidifier system as normal. There is no need to flush the unit!

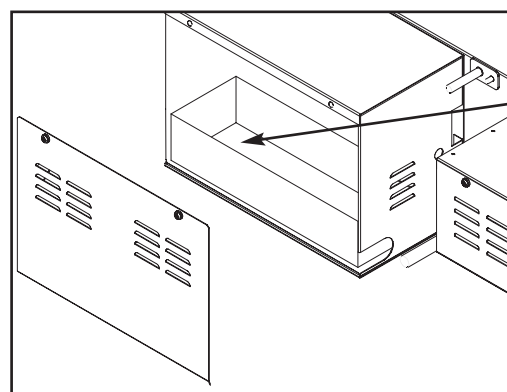



# JS HumiPac™ Humidifier Installation and Instruction Manual Installation

## GENERAL NOTES ON POSITIONING THE HUMIPAC



## PLANNING THE LAYOUT

A minimum ceiling void of at least 300 mm is required for the HumiPac™ ceiling humidifier and an access space of at least 600 mm all round. Provision must be made for fully removing the false ceiling below the unit for maintenance and servicing. Service access will generally be from below and a ladder required. Ensure there is sufficient floor area for a step ladder below the unit. During servicing, residual water in the water tray may spill from the unit. For obvious reasons therefore, do not position the HumiPac™ above water sensitive machinery. Inlet grills should not be positioned above heating or cooling sources as this will adversely affect humidity sensor readings. Maximum duct length is 5 metres for inlet and 5 metres for outlets. Suitable inlet 'egg crate' type grills are recommended and adjustable volume outlet grills fitted with diffusers are required for outlets. Ensure the ceiling is suitable to support the operating weight of the unit and fixing are adequate for the purpose.

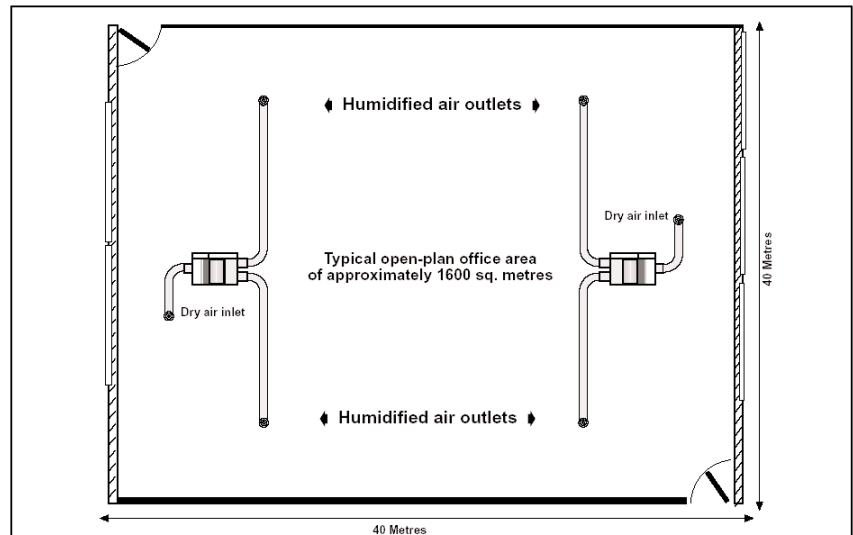

▲ Suggested mounting positions for two HumiPac™ Ceiling Humidifiers in an open plan office.

## YOU WILL NEED

1. JS HumiPac™ unit. Please specify if not mounting above suspended ceiling.
2. All connecting flexible air ducting (250 mm Ø fits onto the oval shaped inlet) - 200mm Ø outlet, together with suitable inlet and outlet diffusers if fixing behind suspended ceiling.
3. Plumbing for the supply of fresh mains water to HumiPac™ unit.
4. Plumbing for the drain connections to HumiPac™ unit.
5. A spirit level.
6. Ceiling fixings (ascertain whether the unit will be affixed to a concrete or traditional timber & joist ceiling).
7. Mains power supply to each HumiPac™ unit. 240V (3 A) fused spur.



# JS HumiPac™ Humidifier Installation and Instruction Manual Installation

## FIXING TO THE CEILING



The JS HumiPac™ ceiling humidifier should be fixed at a suitable point. Standard M10 threaded studding is recommended, as adjustment is required to ensure the unit is absolutely level in all planes. The unit can be attached to the studding using the top or bottom mountings.

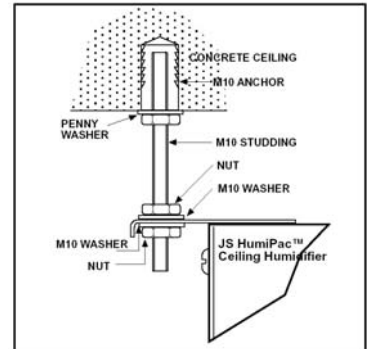

▲ Typical example of ceiling fixing

PLEASE NOTE THE UNIT MUST BE MOUNTED LEVEL IN EACH PLANE.

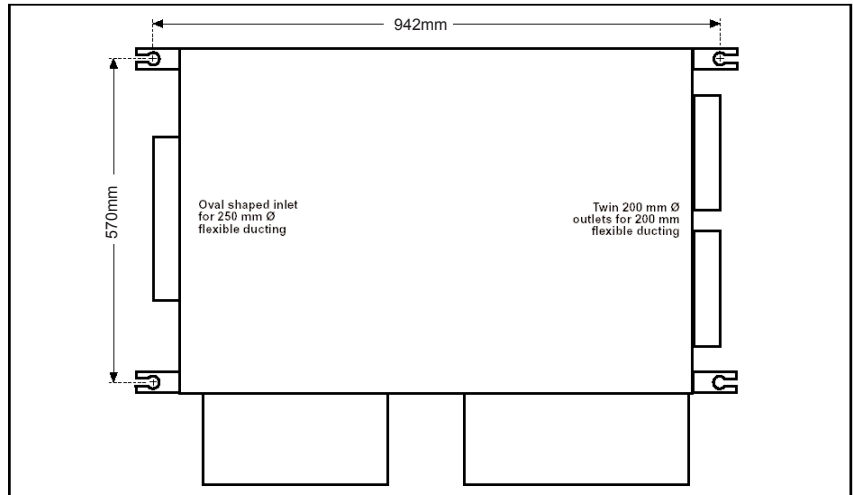

▲ Dimensions for fixing HumiPac™ to the ceiling

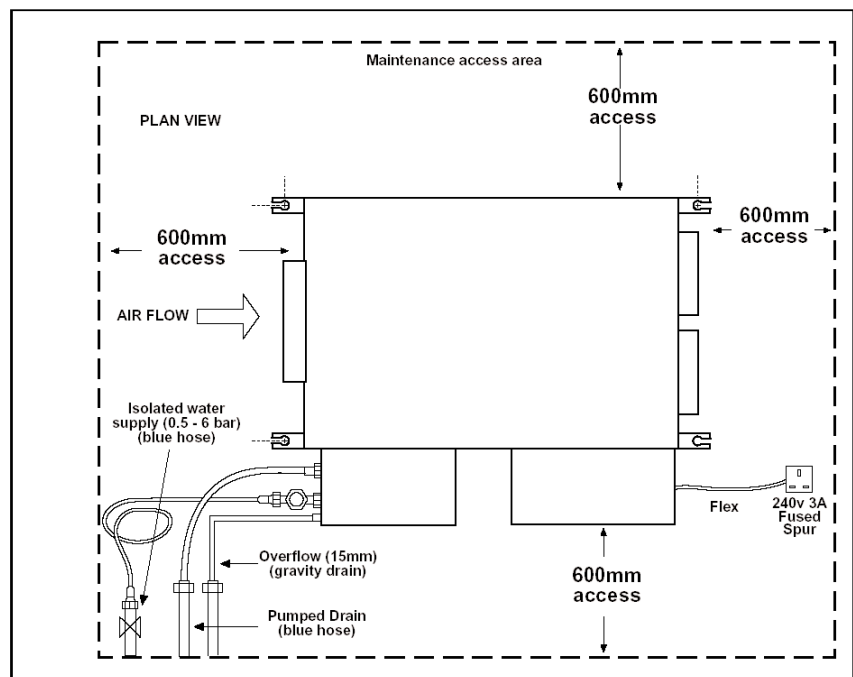

▲ Position terminals of all services within one metre of unit and within access area





# JS HumiPac™ Humidifier Installation and Instruction Manual Installation

## WATER CONNECTIONS

### General

HumiPac™ is supplied with flexible hoses for water and drain connections and 1.5m of electrical flex for connecting to a dedicated mains spur. It is recommended that all services terminate within the 600 mm access area for convenience of installation and servicing.

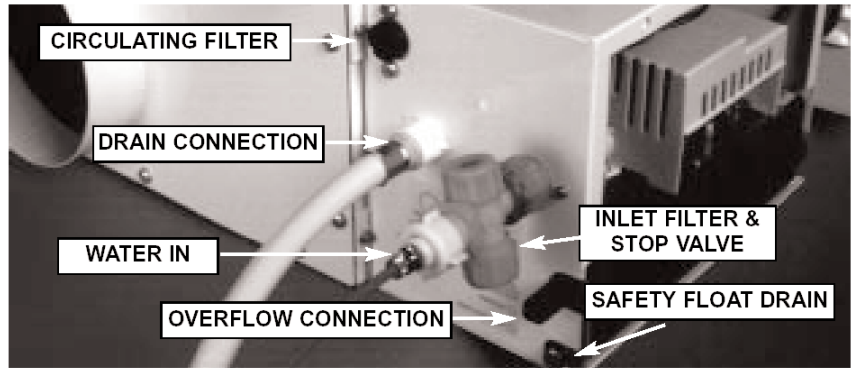

▲ View of HumiPac™ showing water connections

### Water inlet connection.

1. Install 15mm copper/plastic main water isolated water supply to within one metre of HumiPac™ Inlet Filter and Stop Valve\*. Minimum supply pressure 0.5 bar, (Maximum 6 bar).
2. Connect inlet filter and stop valve provided to HumiPac™ water inlet.
3. Connect 6 mm Ø blue nylon hose to water inlet filter and stop valve using 6 mm push fit union provided.
4. Connect 6 mm Ø blue nylon hose to isolated water supply.

\*(The combined inlet filter and stop valve supplied should be used so that the water supply may be isolated if required by unscrewing the plain knob. Do not attempt to unscrew the knob with the red marker).

### Pumped drain connection.

1. Install a 15 mm diameter copper/plastic drain to within one metre of connection point to HumiPac™ pumped drain connection with gradual fall to allow gravity flow from unit.
2. Connect blue flexible hose provided to pumped drain discharge connection on the HumiPac™.
3. Connect the other end of the white hose to the copper/plastic drain. (Note: 0.5m head should not be exceeded).

### Overflow connection.

1. Install min 15 mm copper/plastic drain with gradual fall to allow gravity flow from unit.
2. Remove transportation cap and connect to 15 mm spigot.

(Note: If connecting overflow to the 'pumped drain' terminal ensure pumped water is not able to flow back into the overflow).

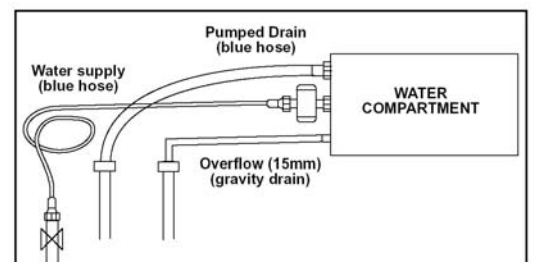

▲ Side elevation showing pumped and overflow drains



# JS HumiPac™ Humidifier Installation and Instruction Manual Installation

## AIR CONNECTIONS

### General

Flexible ducting is specified to ensure that air is drawn into the unit and distributed evenly into the room. Ducting should be suspended independently and not simply laid across the suspended ceiling grid. For this reason too, the use of side entry duct mounting boxes fixed to the ceiling is recommended. Maximum length of ducting for inlet and outlets is 5 metres.

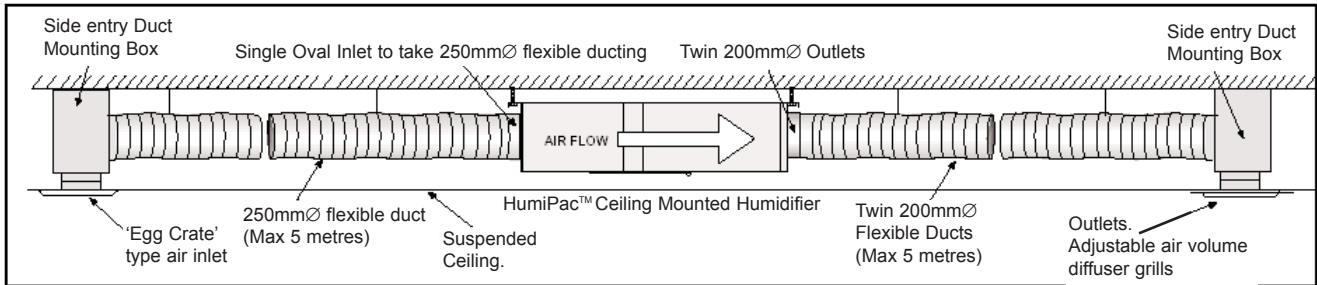

▲ Recommended air connections for the HumiPac™ ceiling mounted humidifier

### Inlet Ducts.

The inlet plenum requires flexible ducting 250mm diameter, (to fit the oval shaped inlet), maximum length 5 metres, an inlet "egg-crate" type grille without resistance of appropriate size and a side entry duct mounting box.

Careful positioning of the grille is necessary and it should be situated away from heating and cooling sources and doors and windows.

Ducting should be attached to the HumiPac™ using the method supplied and suspended independently to avoid any possibility of 'kinking'.

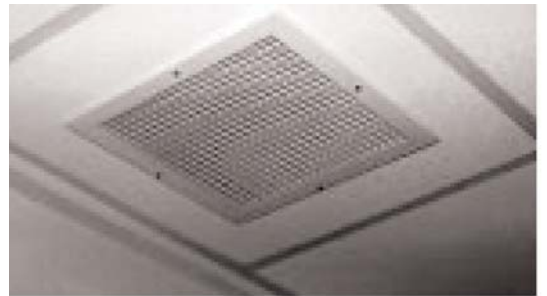

▲ Typical inlet 'egg crate' type grill

### Outlet Ducts.

The outlet plenum requires two flexible duct fittings of 200mm diameter, maximum length 5 metres each, two adjustable volume diffuser outlets of appropriate size and two side entry duct mounting boxes.

Careful positioning of the diffusers is necessary and they should be situated away from heating and cooling sources and doors and windows.

Ducting should be attached to the HumiPac™ using the method supplied and suspended independently to avoid any possibility of kinking.



▲ Typical outlet grill



# JS HumiPac™ Humidifier Installation and Instruction Manual Installation

## ELECTRICAL CONNECTIONS

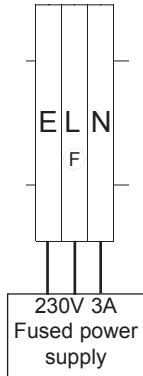

Electrical connections must be performed by qualified electrical personnel. The unit is supplied with a 1.5 metre long single phase lead. This should be connected to a single phase, 240V, isolated fused spur with a 3 Amp fuse installed to within 1 metre of the unit. Isolating the unit is necessary for servicing.

Mains lead wire colour codes are as follows:

Green/Yellow-	Earth
Brown-	Live
Blue-	Neutral

## BMS CONTROLS

### Building Management System Controls

The HumiPac™ can operate as a 'Stand-alone' system or as part of an integrated building management system. Options are available for on/off control and volt free contact common alarm output.

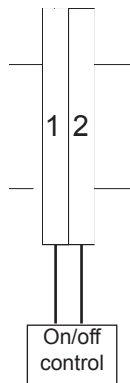

### On/Off Control

This 24Vdc circuit must be closed to enable the humidifier. This connection is normally connected to a BMS. If the humidifier is to be controlled as a stand alone unit these terminals should be linked out.

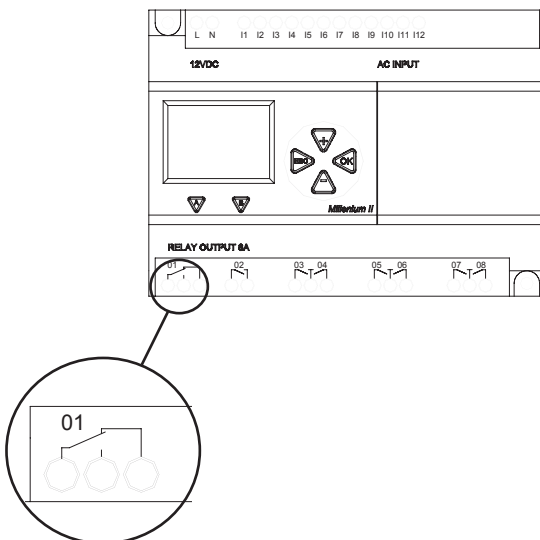

### Common Alarm Output

The common alarm output allows for fault monitoring. Fault monitoring includes high water level and water leak detection. The common alarm output is available either as a normally open or normally closed contact as shown in the diagram opposite. These contacts are rated for up to 230V 2A switching



# JS HumiPac™ Humidifier Installation and Instruction Manual Commissioning

---

## INITIAL START UP PROCEDURE

The following instructions should be closely adhered to when commissioning the JS HumiPac™ Ceiling Humidifier and reference should be made to the safety precautions detailed in the preface. Before switching on the HumiPac™ ensure that the equipment has been installed as detailed in the installation section in this manual.

The JS HumiPac™ Ceiling Humidifier is fully tested and pre-commissioned prior to being dispatched, however, to ensure optimum performance from the unit please follow the steps below.

### Pre commissioning checks

1. Check that the mains water, drain and overflow are connected correctly and securely.
2. Check that the mains power supply, fuses, control and BMS connections, if used, are correctly connected and rated.
3. Ensure that the unit is installed level in both planes. Failure to install level will cause the unit to function incorrectly and may result in false alarms occurring.
4. Purge the water supply line before the unit to ensure that the supply is clean.
5. Ensure the pump tray is completely clear of debris to prevent blocking of the internal filter/restrictor assembly.
6. Switch the power supply to the humidifier on
7. Set the fan speed to 1 ready for the initial commissioning procedure. See operating instructions for details.
8. Enable the humidifier by switching on at the On/Off/Drain switch. The fan will start immediately. Providing there is a humidity demand the water tank will fill and then the pump will start.
9. Allow the unit to prime for a minimum of 10 minutes. Following this time, set the unit to operational mode required. Standard setting is fan speed 2 and a humidity setpoint of 50%rH.

**IMPORTANT:** The HumiPac™ Ceiling Humidifier is designed for continuous operation. For hygiene reasons therefore, should main power to the unit be switched off for long periods, the unit must be drained and disinfected. Please refer to section entitled Disinfection.



# JS HumiPac™ Humidifier

## Installation and Instruction Manual

### Operating the Controller

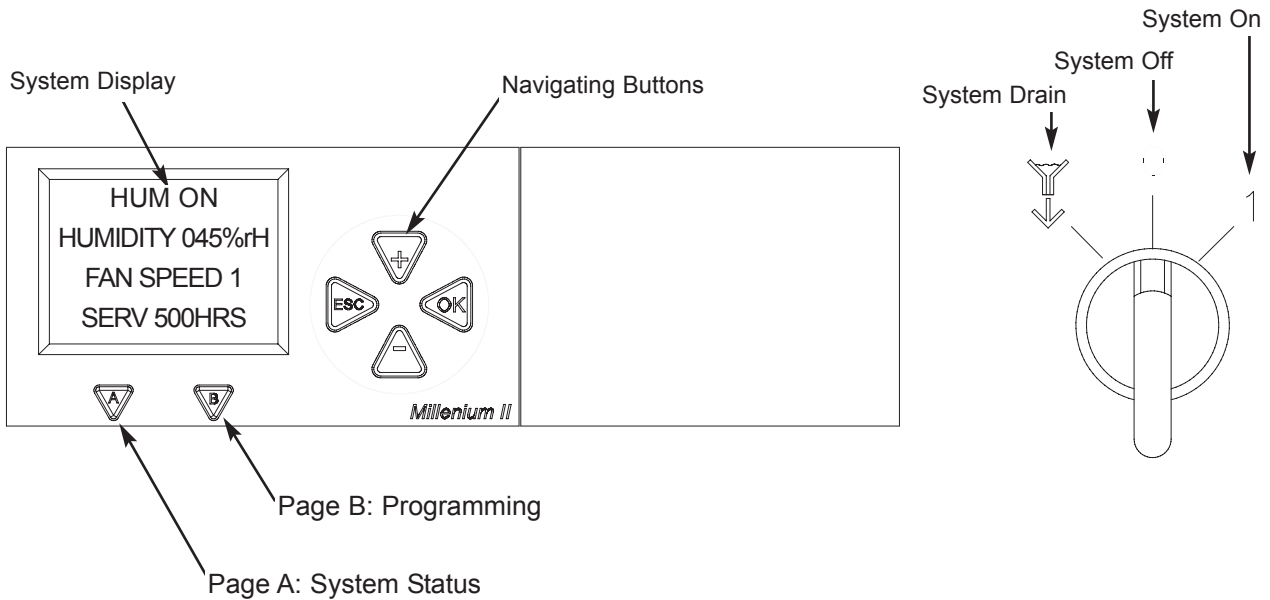

#### System Status Display (Page A)

The system status page will display the following:

HUM ON	→	Humidifier Status. On / Off / Draining / Flushing
HUMIDITY 045%rH	→	The humidity reading of the inlet air
FAN SPEED 1	→	The speed at which the fan is running.
SERV 500HRS	→	The hours remaining of operation until the unit is due for a service

#### Programming (Page B)

The following parameters can be changed using the +, - OK buttons. Use the + and - buttons to highlight the parameter to be changed the press the OK button to access the parameter. Then use the + and - buttons to edit the value. Then finally press OK to confirm.

DRAIN 0003	→	Set drain frequency (Default 3 hours)
SETPOINT 0050	→	Humidity Setpoint (Default 50%rH)
FAN SPEED 0002	→	Fan Speed. Choose fan speed 1, 2, 3 or 0(Auto) (Default Fan Speed 2)
SERV 0500	→	Set service interval (Default 500 hours)



# JS HumiPac™ Humidifier Installation and Instruction Manual Trouble Shooting and Maintenance

## ROUTINE MAINTENANCE

The JS HumiPac™ Ceiling Humidifier requires very little attention. However, for interruption free operation, and for hygiene precautions, maintenance should be carried out at 3-monthly intervals.

**CAUTION: SWITCH OFF AND ISOLATE ALL SUPPLIES BEFORE ATTEMPTING ANY SERVICING OR MAINTENANCE**

The following components require access to the underneath of the unit. This is achieved by removing the two screws and opening the bottom hinged cover. If access is restricted due to an obstruction or lack of roof space then the cover can be completely removed by retracting the hinge pins using the small catches protruding through the back edge of the cover.

**CAUTION: The Fan is accessible when the bottom cover is open. Switch off and isolate the unit and wait for 30 seconds to allow the Fan to slow down and stop before opening the cover.**

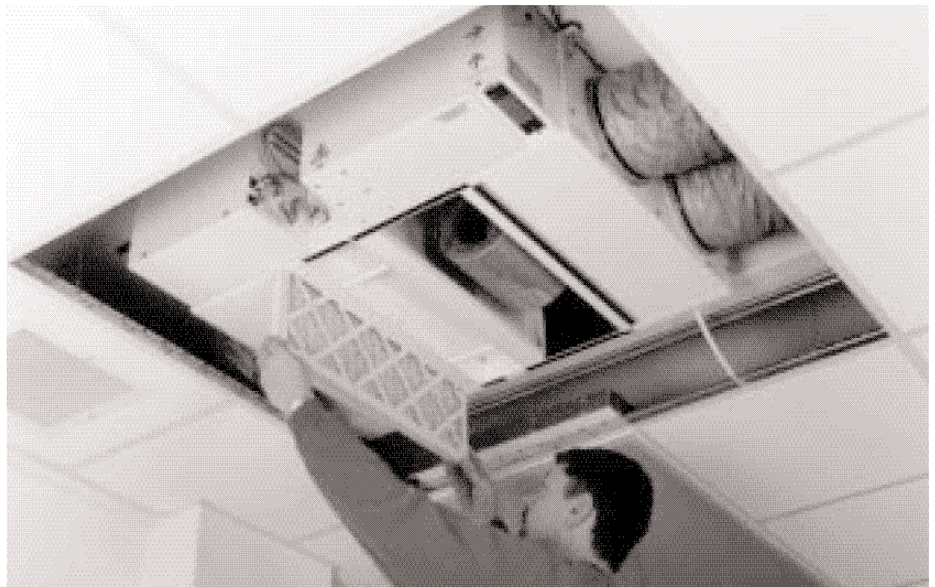

▲ The detachable bottom cover gives access to the antibacterial air filter, humidification cassette and fan

## ANTIBACTERIAL AIR FILTER

### Removing and Replacing the Antibacterial Air Filter (3-monthly intervals)

Open the bottom cover and pull the old air filter out. It may be necessary to use a screwdriver to prize it out. Replace with the correct JS filter, noting the air flow arrow which should be pointing towards the Fan chamber. Fitting unsuitable or incorrect air filter elements will damage the unit and possibly void your warranty.

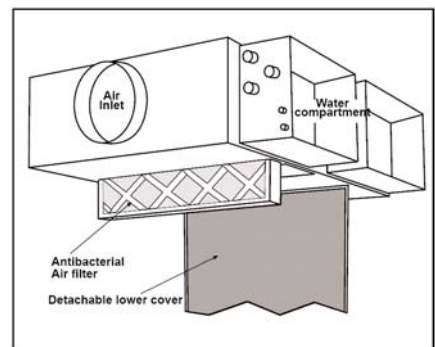



# JS HumiPac™ Humidifier Installation and Instruction Manual Trouble Shooting and Maintenance

## HUMIDIFICATION CASSETTE

### Removing and replacing the Humidification Cassette Assembly

Open the bottom cover. Undo the hose connection between the cassette and water tray. Caution: some water may be present even after using "Manual Drain" button.

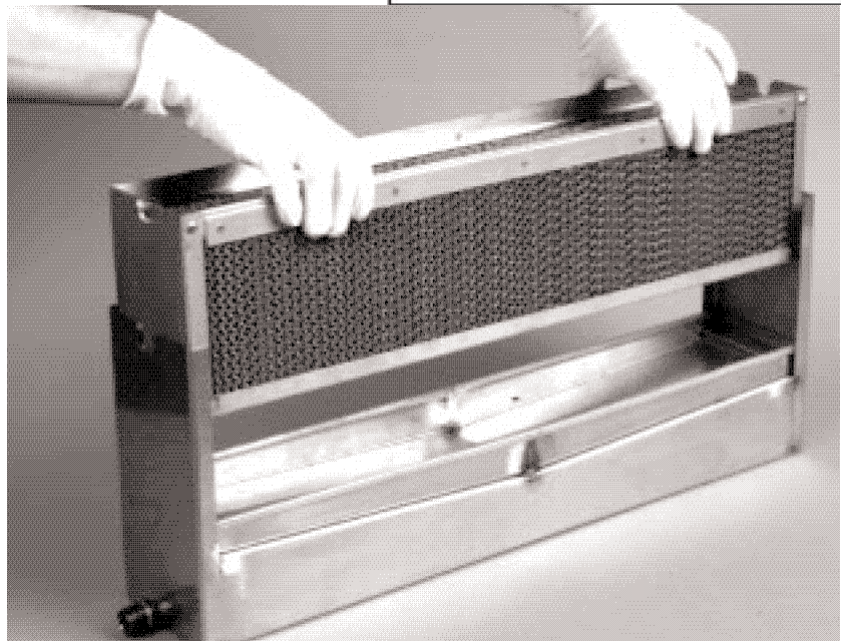
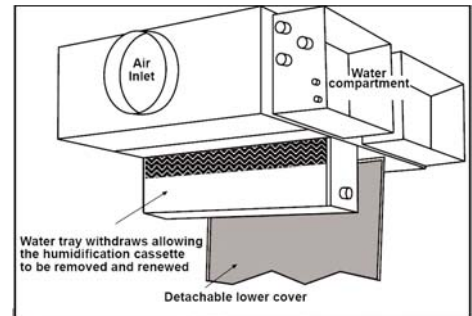

▲ Removing the Cassette from the Water Tray

Remove the locking screw located inside the tray and pull the tray downward using the handles supplied. The actual cassette can be lifted from the water tray and replaced with the new cassette. Replacement is the reverse of removal.

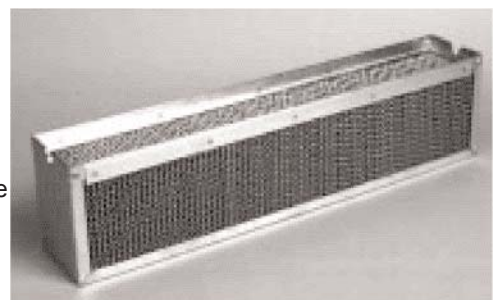

▲ The Humidification Cassette

## CENTRIFUGAL FAN

### Removing and replacing the Fan

Open the bottom cover. Isolate the unit and undo the electrical connection to the fan. This involves removing the cable from the connection attached under the fan itself. The fan and fan deck are designed to be removed as one assembly and there are 4 screws which hold it in place; two on each side. On one side these are easily accessible. The other two are accessible through the back of the electrical compartment. The fan deck will now pull down from the main body. The fan can be simply unbolted from the fan deck plate when replacing the assembly by undoing the screws and holding the motor.



# JS HumiPac™ Humidifier Installation and Instruction Manual Trouble Shooting and Maintenance

## WATER SPRAY BAR

### Removing and replacing the Spray Bar

Place a suitably sized spanner or similar tool between the hose connector and the main body and pull towards you, away from the main body. Constant pressure on the plastic ring will release the grip mechanism allowing the connector to slide off the stainless steel Spray Bar. The actual Spray Bar is located by the M6 nut and once this is removed the Spray Bar can be pulled out from the side of the unit. When replacing the Spray Bar ensure that the sealed end is properly located into the holder inside the humidifier cassette chamber. It will be necessary for the humidifier cassette to be removed to check this.

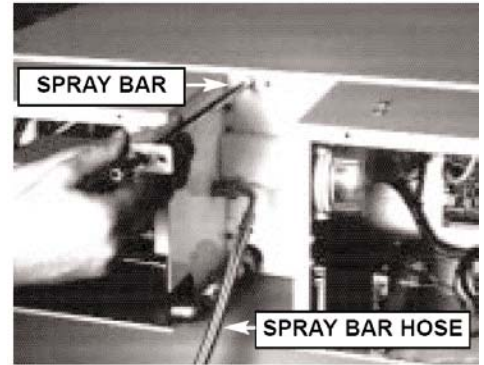

The following items require access to the Left-hand water enclosure. Before removing the cover press the Manual drain button (See section on Layout and Function of Controls) and when the 'Fault' LED is lit switch the mains switch Off and isolate the unit.

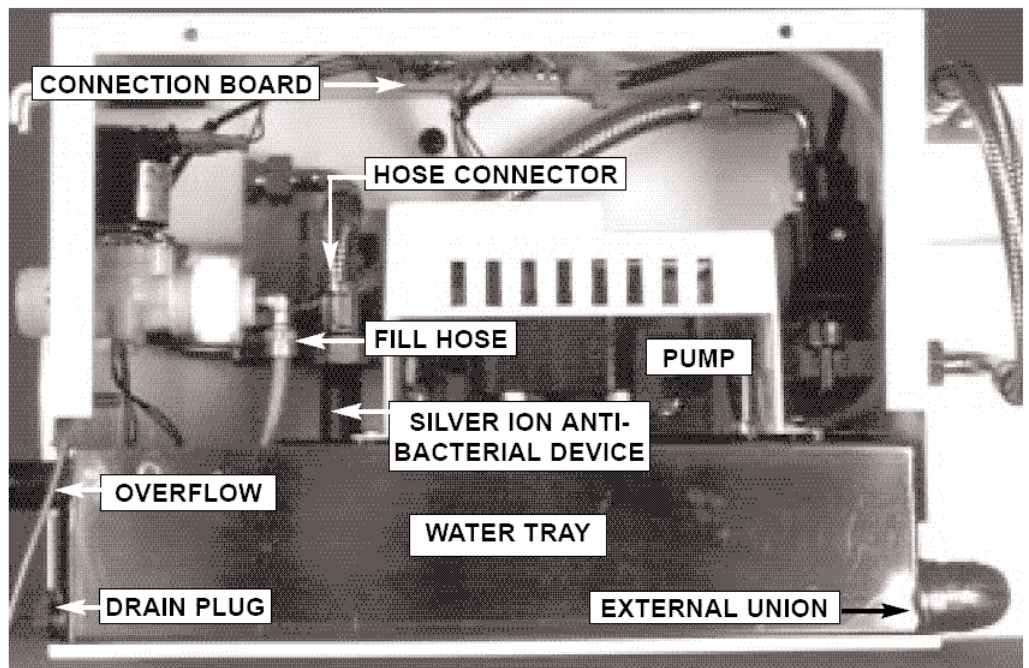

▲ The pump and water tray in their compartment

## WATER PUMP

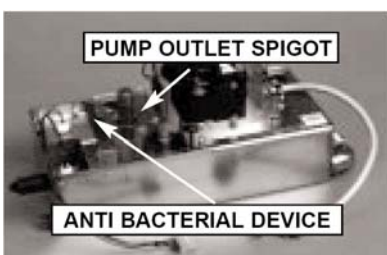

### Removing and replacing the Pump

Remove the water compartment cover. Remove the water tray fill hose from the inlet valve and undo the hose connector from the pump outlet spigot. Caution is necessary when undoing the external union between the water tray and humidification cassette as some water may be present even after using the 'Manual Drain' button. Disconnect the 5-pin and 4-pin plugs for the pump and float switch respectively from the small connection board; the water tray can now be removed. The actual pump assembly is screwed to the stainless steel tray with 4 screws.





# JS HumiPac™ Humidifier Installation and Instruction Manual Trouble Shooting and Maintenance

## WATER FILTERS

Removing and replacing the water filters (3-monthly intervals)

The JS HumiPac™ Ceiling Humidifier has two water filters; one on the inlet, and one between the pump and the humidification cassette. The inlet filter can be checked and/or replaced

by unscrewing the cap marked open/closed and removing it. This filter also acts as a stopcock and one-way valve so that when the cap is unscrewed the mains water supply is automatically cut-off. Do not remove the opposite cap marked with a red dot.

The other in-line filter is accessible by unscrewing the plug on the side of the water enclosure by the

drain connection. Make sure that the unit is off before attempting to unscrew the cap. These two filters are different and therefore not interchangeable.

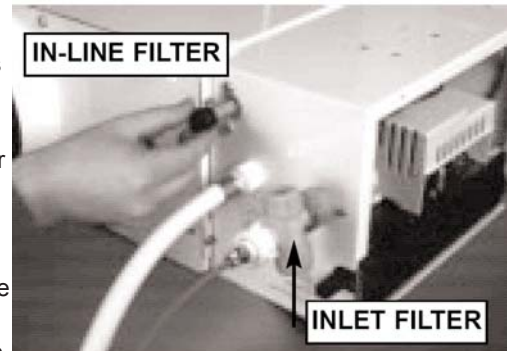

## HUMIDITY SENSOR

The humidity sensor is mounted on the water compartment bulkhead and extends through the air inlet plenum to measure the relative humidity of the inlet air. The humidity sensor controls the degree of humidification required to restore the set point rH.

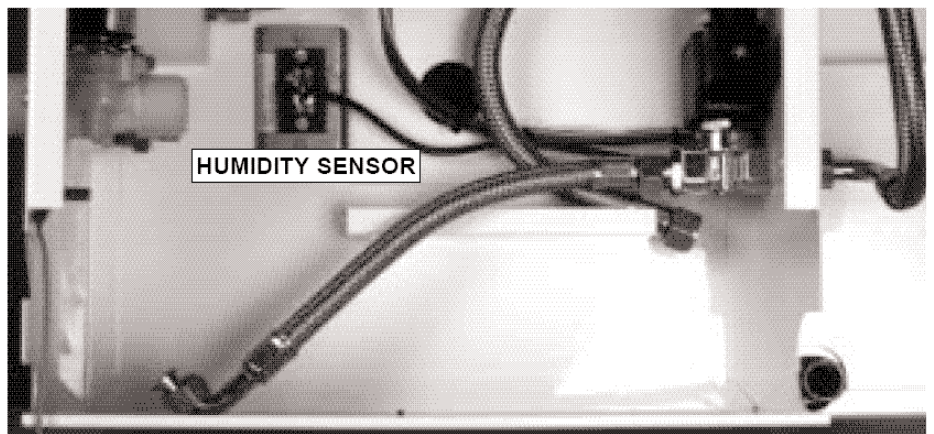

▲ Access to the Humidity Sensor is via the back of the water compartment.



# JS HumiPac™ Humidifier Installation and Instruction Manual Trouble Shooting and Maintenance

---

## FAULT DIAGNOSTIC

### **HWL Fault (High Water Level Fault)**

1. An excessively high level of water in the water tray will cause the High Water Level safety cut-out to trip. When the High Water Level safety cut-out has been tripped, the unit will initiate a Drain Cycle to return the water level to a safe level. This fault will switch the common fault alarm contacts.

This fault can be caused by the unit not being installed level, a pump failure or leaking inlet solenoid valve. (See section on Removing and Replacing the Pump). If the water level continues to rise, it will trip a mechanical interlock safety float switch, breaking any power supply to the inlet solenoid and then go to drain via the overflow. The mechanical interlock safety float switch is not linked to the fault indicator.

### **WLD Fault (Water Leak Detection Fault)**

Should condensation or water build up within the fan chamber, a condensation detection device will trip and initiate a drain cycle. The unit will then shut down and trigger a fault warning LED and audible alarm. This may be caused by a build up of minerals across the humidifier cassette matrix which then should be replaced.

## SERVICE ALARM

When the hours run exceed the service schedule the common faults contacts will switch and the display will show "Service Due" Once the service has been completed the service counter can be reset by pressing the "A" and "B" buttons simultaneously.

## DISINFECTION OF THE WATER SYSTEM

Should the HumiPac™ unit be switched off for any period of time, and at three monthly intervals, it is recommended that the unit is disinfected. The water supply should be turned off and a Disifin tablet inserted into the water tank. The water should then be turned on and the unit allowed to recommence operating normally.



# JS HumiPac™ Humidifier

## Installation and Instruction Manual

### Technical Specifications

#### TECHNICAL DATA

Power Supply	230V ~ 50Hz	Min/Max Inlet Pressure (Bar)	0.5/6.0
Amp (A)	1.2	Drain Connection (BSP)	1/2"
Watts (kW)	0.3	Overflow Connection (mm)	15
Fan Speed	1 300 m3/h	Weight (Kg)	46
Fan Speed 2	440 m3/h	Width (mm)	785
Fan Speed 3	570 m3/h	Length (mm)	1010
Inlet connection (BSP)	1/2"	Depth (mm)	240

#### CHART TO SHOW AIRFLOW AGAINST APPLIED EXTERNAL PRESSURE

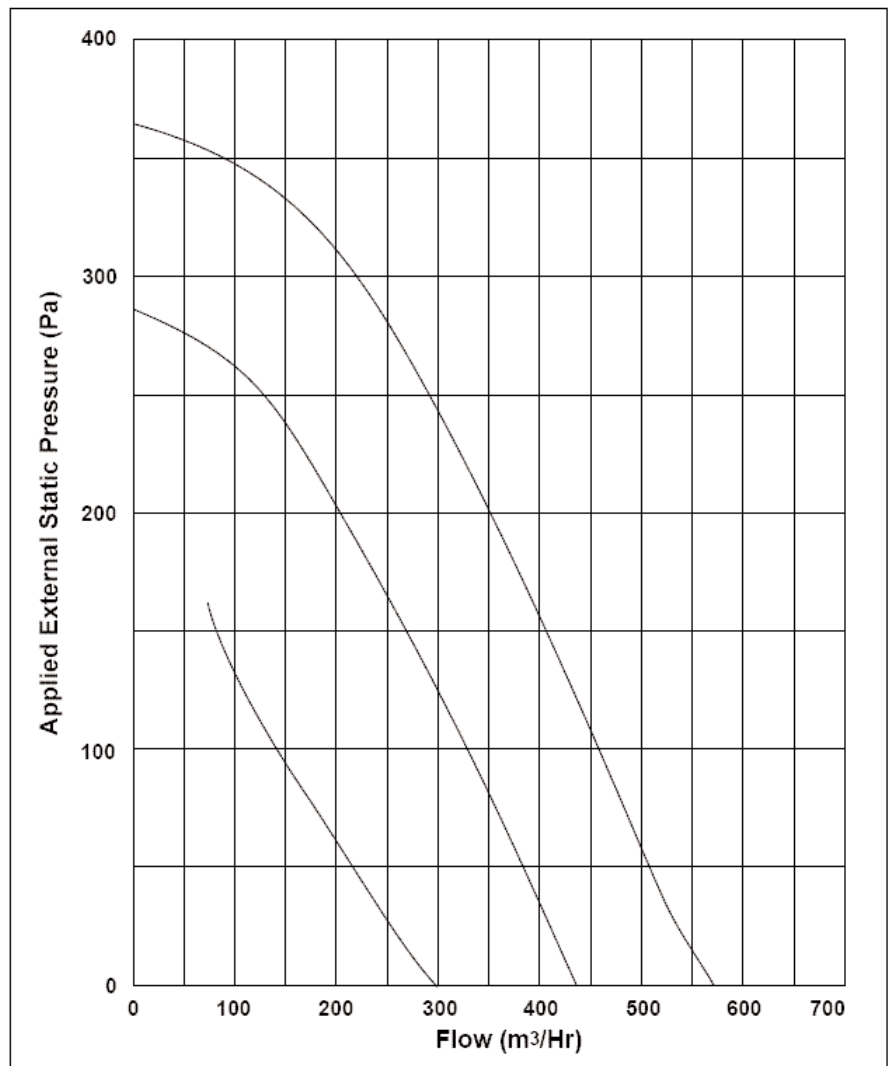



# JS HumiPac™ Humidifier Installation and Instruction Manual Service Intervals and Consumables

## RECOMMENDED SERVICING SCHEDULES

Part Description:	Service Interval:
Antibacterial Air Filter (04017)	3 Monthly
Inlet Strainer Element (04078)	3 Monthly
Circulating Strainer Element (SCREENIT)	3 Monthly
Humidifier Cassette Matrix (04077)	Annually*
Full Service	Annually

## Consumables:

## Part Number:

Antibacterial Air Filter Element	04016
Humidifier Matrix Cassette	04077
Inlet Strainer Element	04078
Circulating Strainer Element	SCREENIT
Anti-Bacterial Device	04080
Disifin Disinfection Tablet (Small, QTY: 25)	DISFIN
Annual Service Kit	04081
<small>(Comprises... Matrix Cassette, 4x Antibacterial Air Filters, 4x Circulating Strainers, 4x Inlet Strainers, 4x Fibre Washers.</small>	

\* Depending upon water quality.

## PART NUMBERS

### Code Description

- 04073 10m x 200mm flexible ducting
- 04074 Adjustable 200mm outlet grille for suspended ceilings, complete with 2 duct clips (NOTE - 2 grills required per HumiPac)
- 04075 200mm x 200mm fixed inlet grille, side connection with 2 duct clips
- 04076 Hose clip for 200mm flexible ducting

